

**Programmable safety controller
SCR P**

Safety controller SCR P

The smart solution for machine safety

MANY ADVANTAGES AT A GLANCE

- Reduction of downtimes
- Reduce hardware costs
- Quick and simple configuration
- Testing the configuration in simulation mode
- Simple troubleshooting in live mode
- Configuration cloning via programming flash drive

VARIOUS APPLICATION POSSIBILITIES



HIGHLIGHTS

- Provision of DCD diagnostic data via selectable Ethernet protocols
- Two independent enabling paths
- Intuitive user interface
- Simple program creation via Drag & Drop
- Live and simulation mode

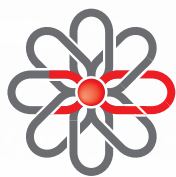

DAISY CHAIN
DIAGNOSTICS

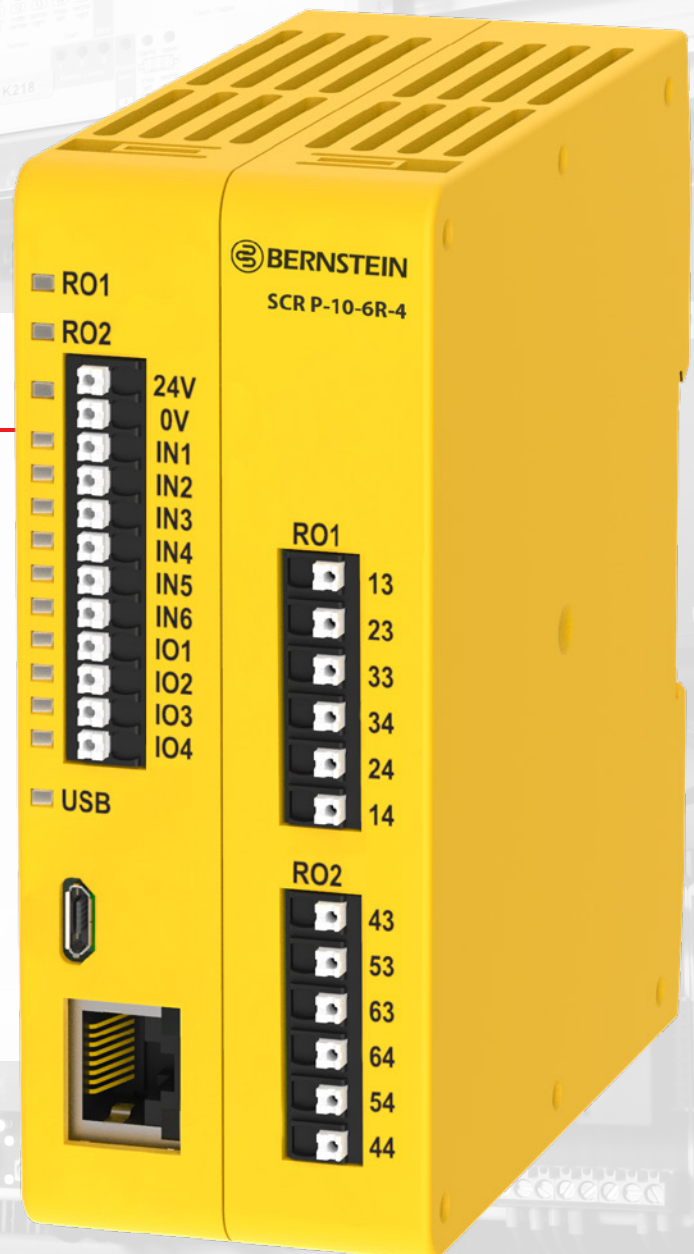



Definitely the right solution.

Innovative all-rounder

The programmable safety controller of the SCR P series is a smart alternative to the classic safety relays. Due to its multitude of applications it can replace various safety relay modules. This saves not only costs but also time, wiring effort and space. Up to 5 possible safety circuits with a max. of PL e, thereof 2 circuits with innovative DCD diagnostics allow logical connections to distinctively shutdown certain parts of a machine. Extensive diagnostic information can be retrieved via the Ethernet interface.

Versatile I/O capabilities

The SCR P offers 10 safe inputs: 4 of them can be converted into non-safe outputs by software. A total of 4 inputs are available for the patented DCD diagnostic system. This allows up to 64 DCD devices can be connected. The two 2-channel relay outputs, each with a switching capacity of 6 amps, enable independent safety circuits to be implemented with just one controller.

(Software with) Intuitive Look & Feel

The icon-based Drag & Drop user interface of the free programming software from BERNSTEIN simplifies the configuration of a safety function. The software automatically generates logic and circuit diagrams for the necessary documentation. Users can test configurations in simulation mode before implementation – thus reducing the risk of errors. In case wiring faults have occurred, they can be quickly identified in the live mode of the software.

MACHINE

Zone 1

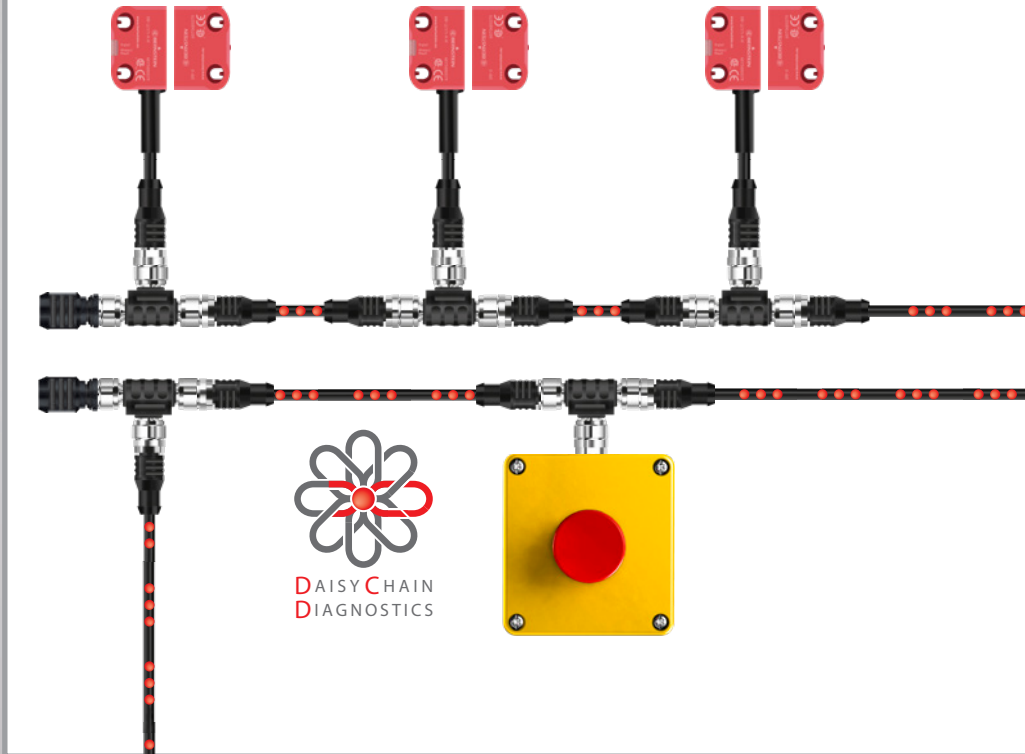

Zone 2

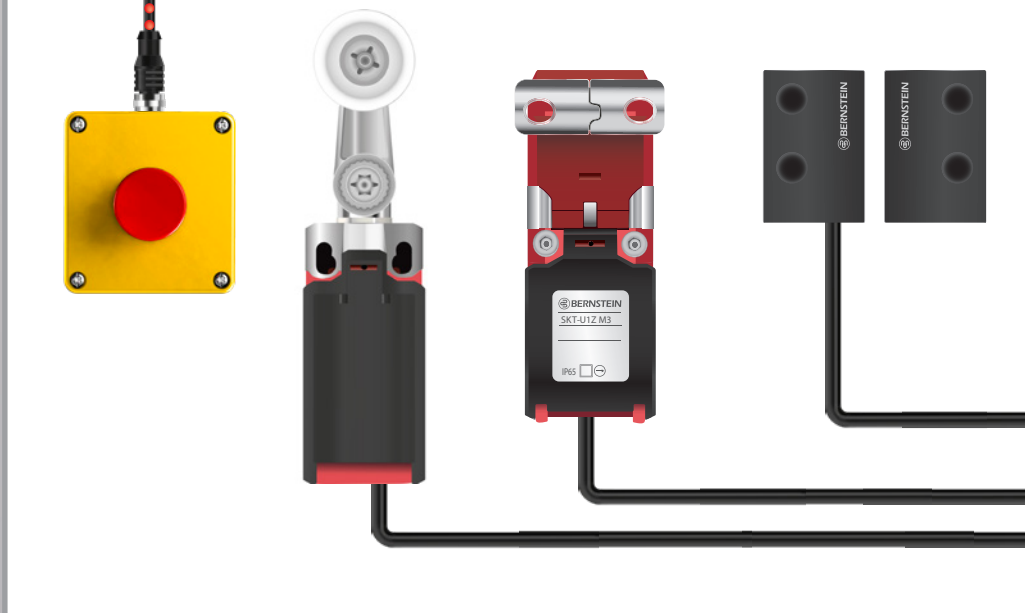

Easy to use

- Certified function blocks
- Intuitive program creation by Drag & Drop
- Automatic prevention of incorrect connections
- Integrated simulator for test configuration
- Free configuration software

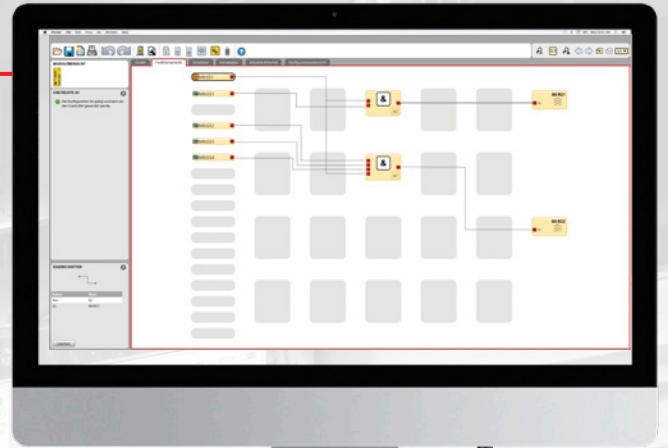

DCD Diagnostics

The SCR P can be used to connect two DCD safety circuits with up to 32 BERNSTEIN SMART Safety devices each. With the aid of the DCD diagnostic system, each device in the chain transmits its diagnostic data. The SCR P receives this information and makes it available to the machine controller. This is done via a fieldbus protocol pre-configured in the software.

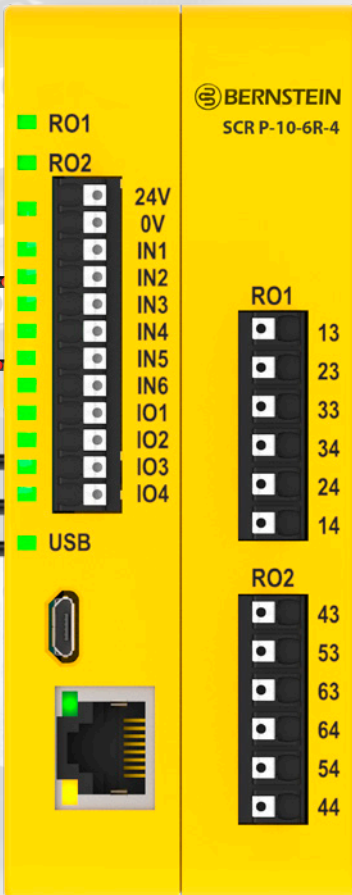

**PROFI
NET**

EtherNet/IP

Modbus



Four steps to PLC connection

1. Create safety configuration
 2. Perform automatic interface configuration
 3. Establish hardware connection via selected fieldbus
 4. Integrate SCR P into the hardware configuration of the PLC using the device description file
- Ready! All information and diagnostic data are now available in the PLC.

Technical Data

SCR P safety controller

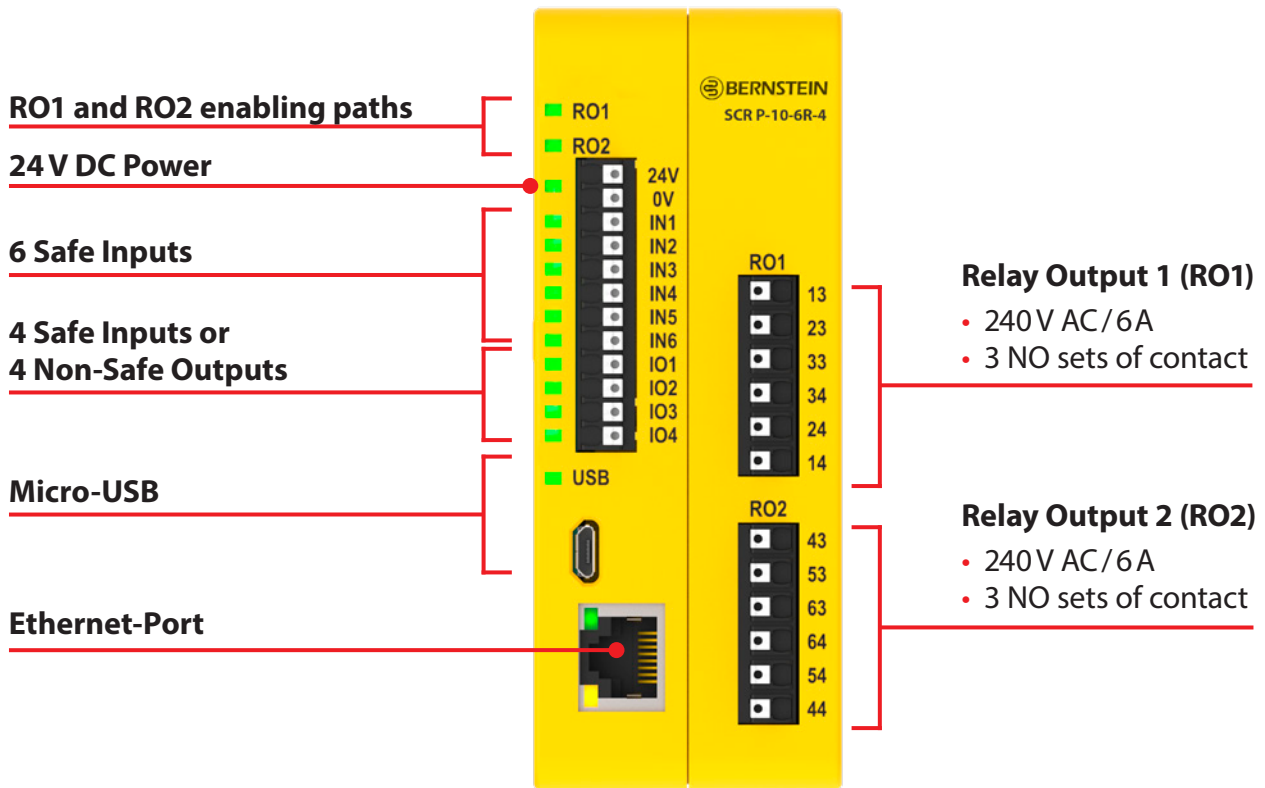

Order details

Product selection		
Article number	Designation	Description
6075133159	SCR P-10-6R-4	Programmable safety controller

Accessoires

Product selection		
Article number	Designation	Description
3991000251	USB-cable A/ Micro-B	
3991000252	Programming flash drive SCR P-FPS	
3991000250	USB-programming adapter SCR P-PA	

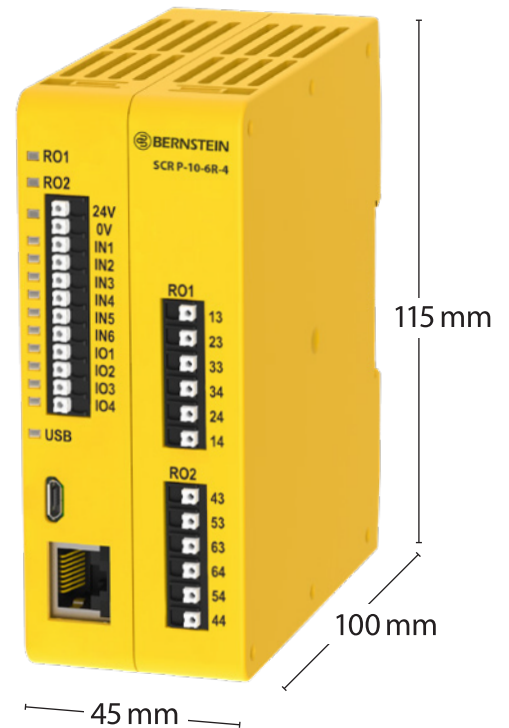



**We make
safety happen.**



**We keep safe
your visions.**

Contact

International Headquarters BERNSTEIN AG

Hans-Bernstein-Str. 1
32457 Porta Westfalica
Fon +49 571 793-0
Fax +49 571 793-555
info@de.bernstein.eu
www.bernstein.eu

Denmark BERNSTEIN A/S

Fon +45 7020 0522
Fax +45 7020 0177
info@dk.bernstein.eu

France BERNSTEIN S.A.R.L.

Fon +33 1 64 66 32 50
Fax +33 1 64 66 10 02
info@fr.bernstein.eu

Italy BERNSTEIN S.r.l.

Fon +39 035 4549037
Fax +39 035 4549647
info@it.bernstein.eu

United Kingdom BERNSTEIN Ltd

Fon +44 1922 744999
Fax +44 1922 457555
info@uk.bernstein.eu

Austria BERNSTEIN GmbH

Fon +43 2256 62070-0
Fax +43 2256 62618
info@at.bernstein.eu

Switzerland BERNSTEIN (Schweiz) AG

Fon +41 44 775 71-71
Fax +41 44 775 71-72
info@ch.bernstein.eu

Hungary BERNSTEIN Kft.

Fon +36 1 4342295
Fax +36 1 4342299
info@hu.bernstein.eu

China BERNSTEIN Safe Solutions (Taicang) Co., Ltd.

Fon +86 512 81608180
Fax +86 512 81608181
info@bernstein-safesolutions.cn

www.bernstein.eu